

richtig schreiben

Schraube & **Mutter**

Dieses Heft gehört:

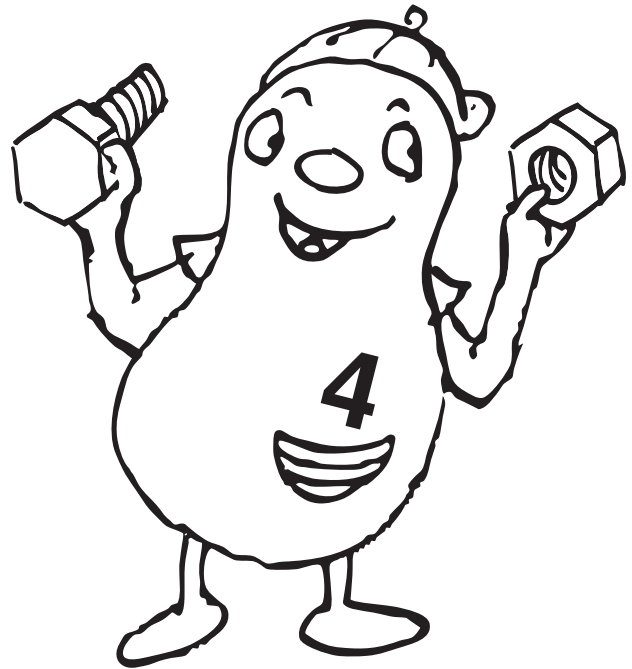

richtig schreiben

Schraube & **Mutter**

Dieses Heft gehört:

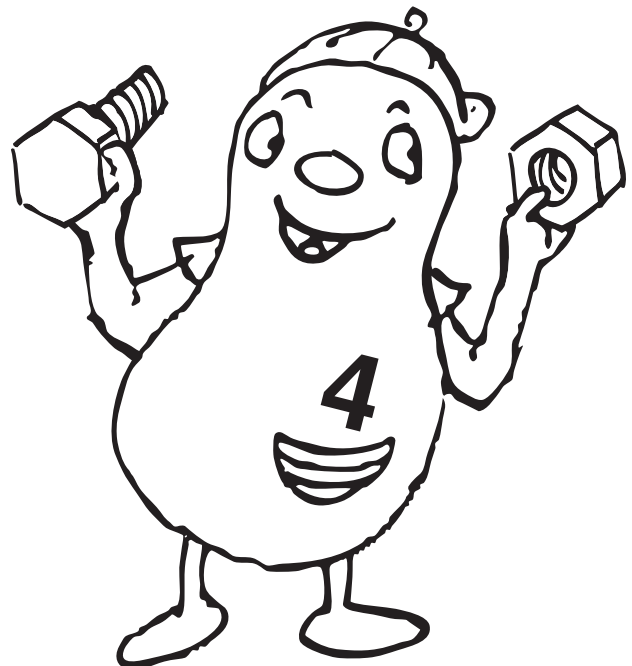



-e

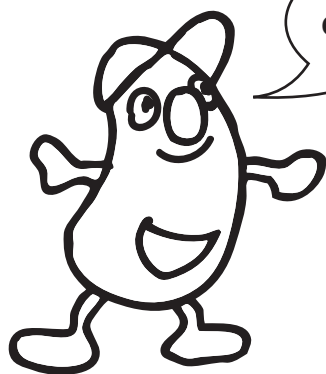

Viele Wörter
enden mit einem
kurzen *e*.



Oft ist es
schwer, das *e*
zu hören.



1



-e

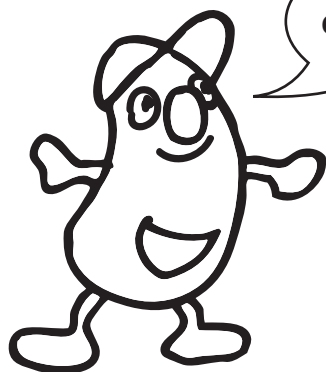

Viele Wörter
enden mit einem
kurzen *e*.



Oft ist es
schwer, das *e*
zu hören.



1



Verbinde.

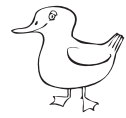

-e

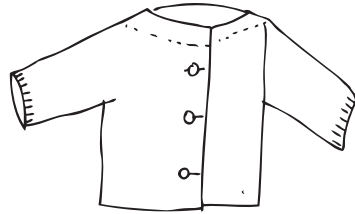

Rakete

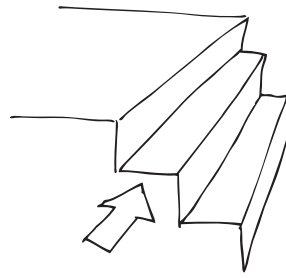

Wäsche

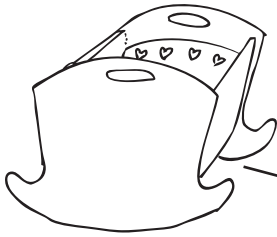

Wiege

Jacke

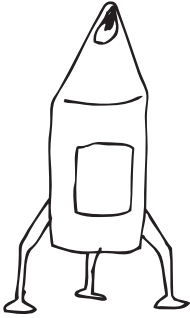

Liste

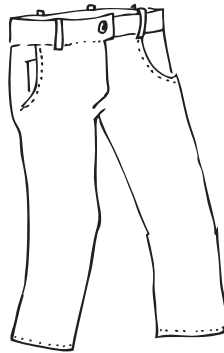

Hose

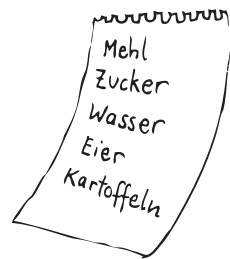

2



Verbinde.

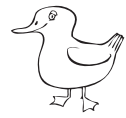

-e

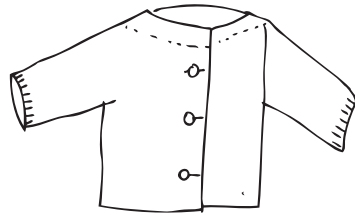

Rakete

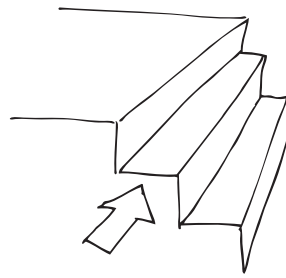

Wäsche

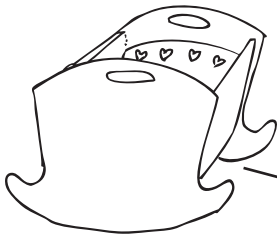

Wiege

Jacke

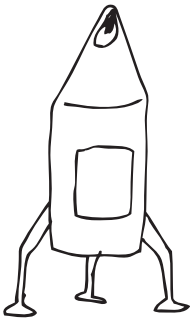

Liste

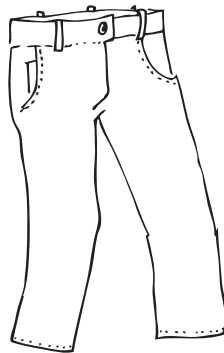

Hose

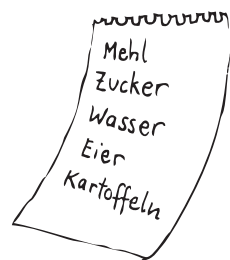

2



Verbinde.

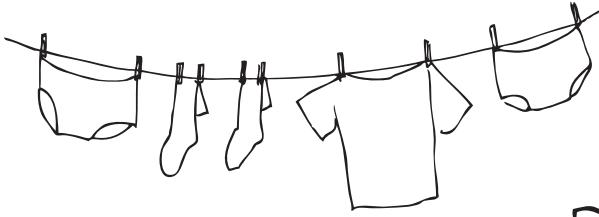

Stufe



Note



Dose

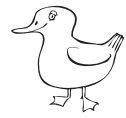

-e

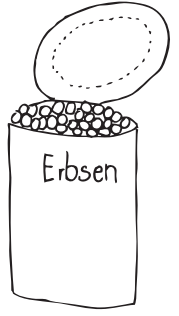

Rabe

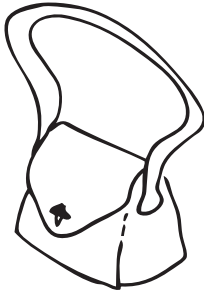

Tasche



Tulpe



Rose



Verbinde.

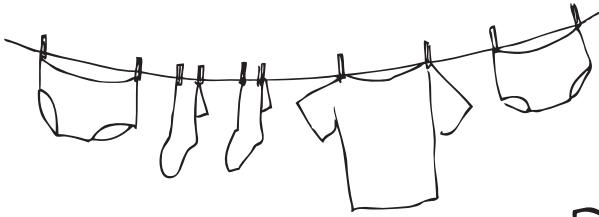

Stufe

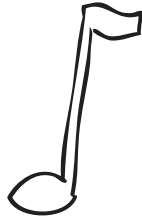

Note



Dose

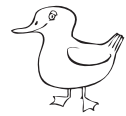

-e

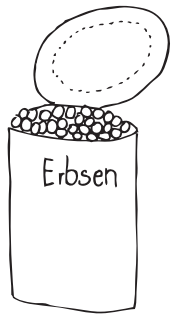

Rabe

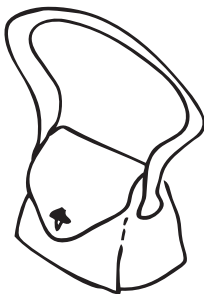

Tasche



Tulpe



Rose



Schreibe.

Denk daran: Im Wort wird klein geschrieben.

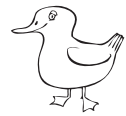

-e

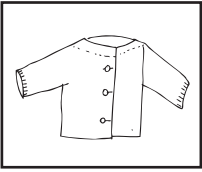

die Jack 

die Jacke die

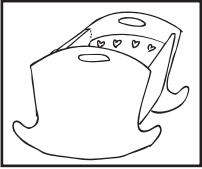

die Wieg 

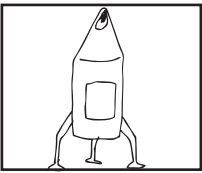

die Raket 

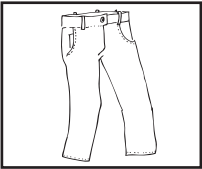

die Hos 

4



Schreibe.

Denk daran: Im Wort wird klein geschrieben.

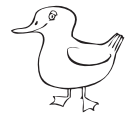

-e

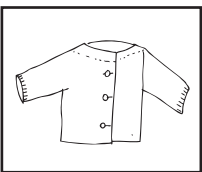

die Jack 

die Jacke die

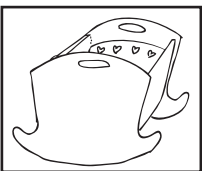

die Wieg 

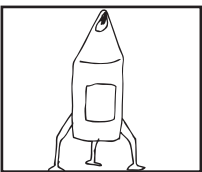

die Raket 

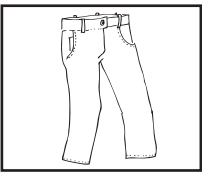

die Hos 

4

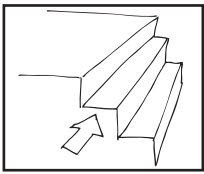

die Stuf

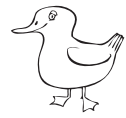

-e

Blank writing lines for the word 'die Stufen'.



die List



Blank writing lines for the word 'die Liste'.

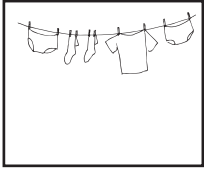

die Wäsch



Blank writing lines for the word 'die Wäsche'.



die Not



Blank writing lines for the word 'die Note'.

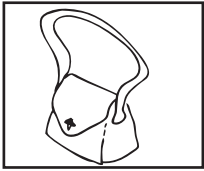

die Tasch



Blank writing lines for the word 'die Tasche'.

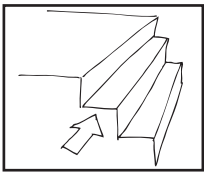

die Stuf

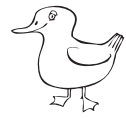

-e

Blank writing lines for the word 'die Stufen'.



die List



Blank writing lines for the word 'die Liste'.

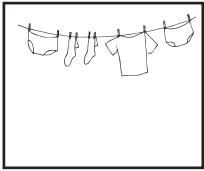

die Wäsch



Blank writing lines for the word 'die Wäsche'.

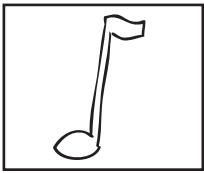

die Not



Blank writing lines for the word 'die Note'.

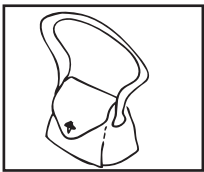

die Tasch



Blank writing lines for the word 'die Tasche'.



Schreibe.

Denk daran: Im Wort wird klein geschrieben.

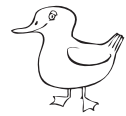

-e



der Rab

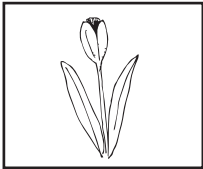

die Tulp

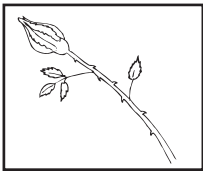

die Ros

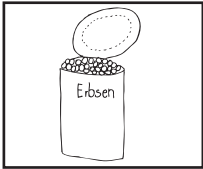

die Dos



6



Schreibe.

Denk daran: Im Wort wird klein geschrieben.

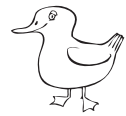

-e



der Rab

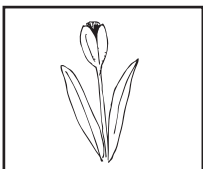

die Tulp



die Ros

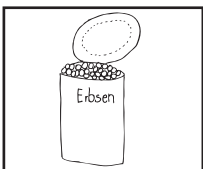

die Dos



6



Kreise ein.
Welche Wörter enden auf **-e** ?

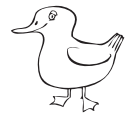

-e

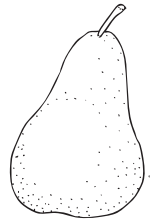
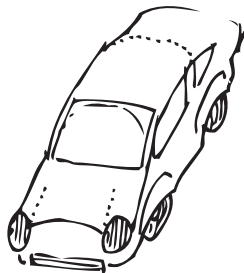
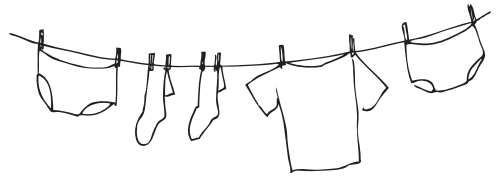
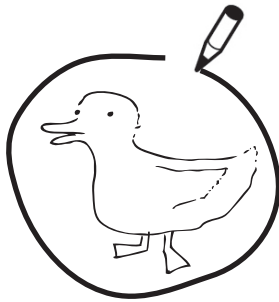
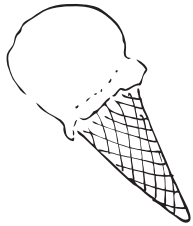
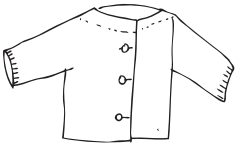

7



Kreise ein.
Welche Wörter enden auf **-e** ?

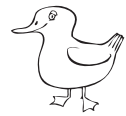

-e

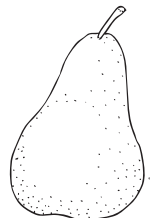
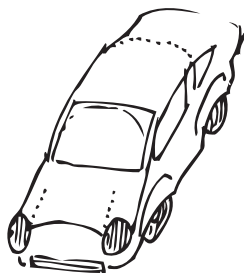
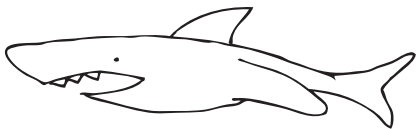
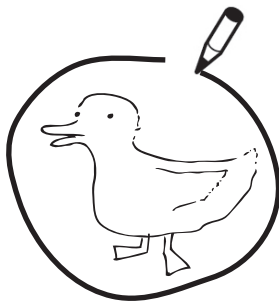
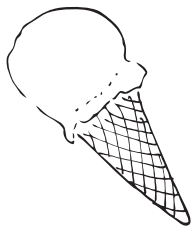
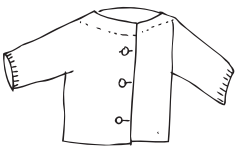

7



Verbinde.



-e

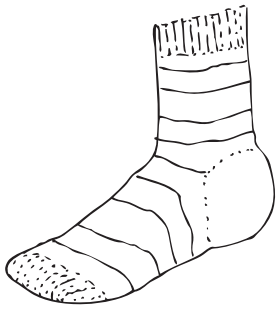

Socke

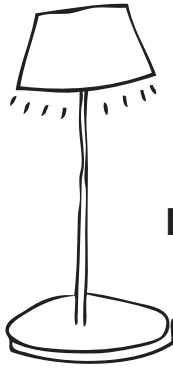

Kiste

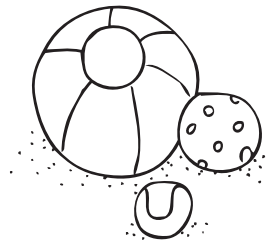

Wolle

Bälle



Lampe

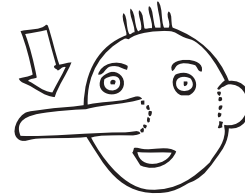
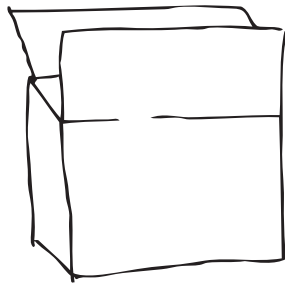

Ente

8



Verbinde.

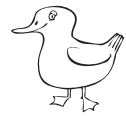

-e



Socke

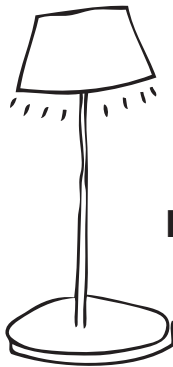

Kiste

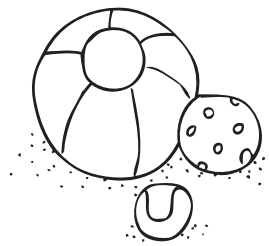

Wolle

Bälle



Lampe

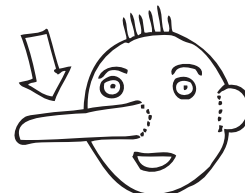
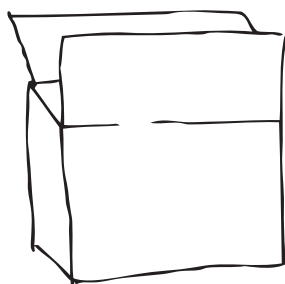

Ente

8

 **Verbinde.**

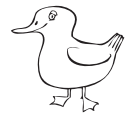

-e

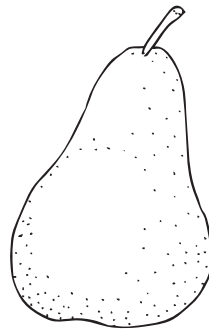
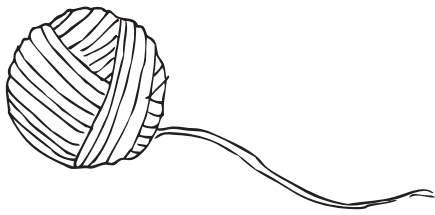

Birne

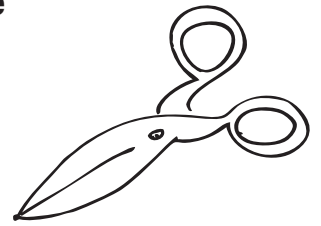

Wolke



Bürste

Nase

Schere

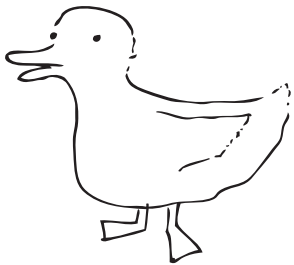

Spinne

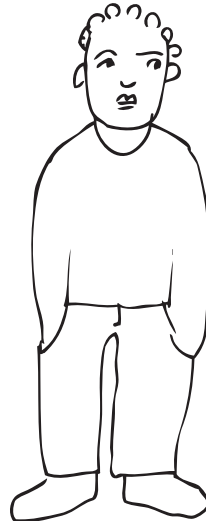

Junge

9

 **Verbinde.**



-e

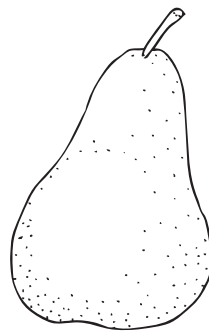
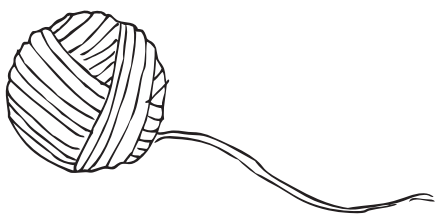

Birne

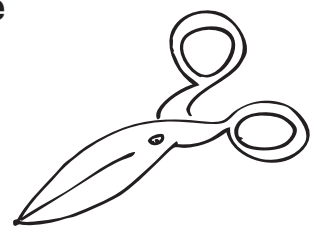

Wolke



Bürste

Nase

Schere

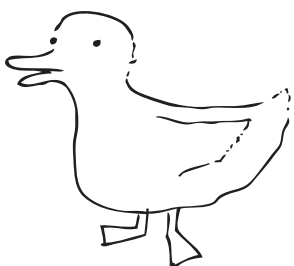

Spinne



Junge

9



Schreibe.

Denk daran: Im Wort wird klein geschrieben.



-e

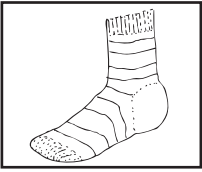

die Sock 

die Socke die

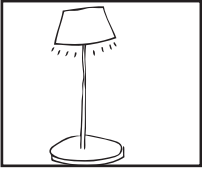

die Lamp 

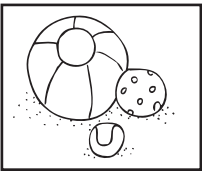

die Bäll 

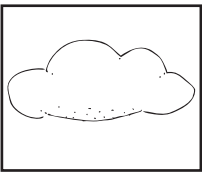

die Wolk 

10



Schreibe.

Denk daran: Im Wort wird klein geschrieben.

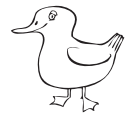

-e

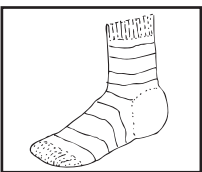

die Sock 

die Socke die

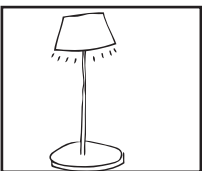

die Lamp 

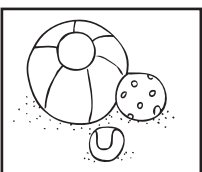

die Bäll 

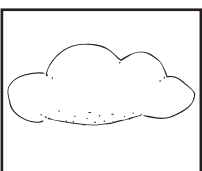

die Wolk 

10

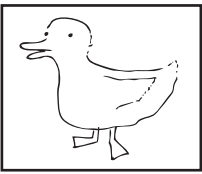

die Ent



-e

Blank writing lines for the word 'die Ent'



die Spinn



Blank writing lines for the word 'die Spinn'

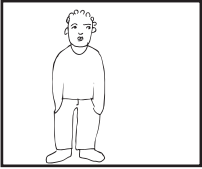

der Jung



Blank writing lines for the word 'der Jung'

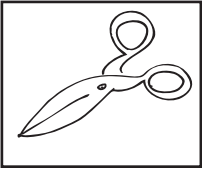

die Scher



Blank writing lines for the word 'die Scher'

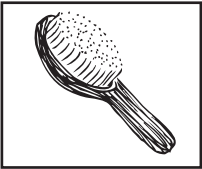

die Bürst



Blank writing lines for the word 'die Bürst'

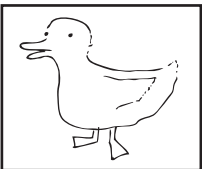

die Ent

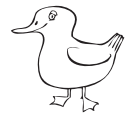

-e

Blank writing lines for the word 'die Ent'



die Spinn



Blank writing lines for the word 'die Spinn'

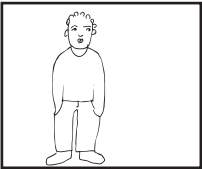

der Jung



Blank writing lines for the word 'der Jung'

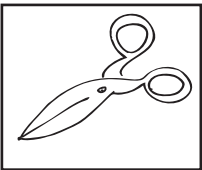

die Scher



Blank writing lines for the word 'die Scher'

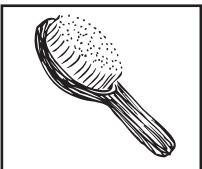

die Bürst



Blank writing lines for the word 'die Bürst'



Schreibe.

Denk daran: Im Wort wird klein geschrieben.

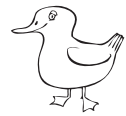

-e

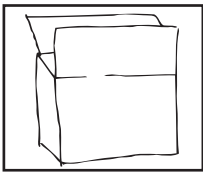

die Kist

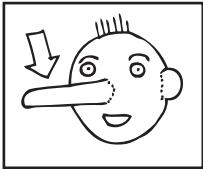

die Nas

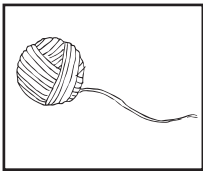

die Woll

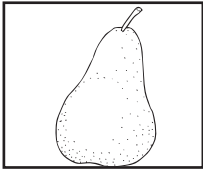

die Birn



12



Schreibe.

Denk daran: Im Wort wird klein geschrieben.

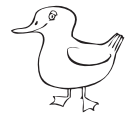

-e

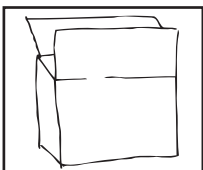

die Kist

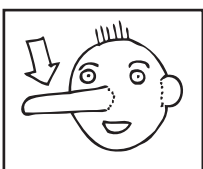

die Nas

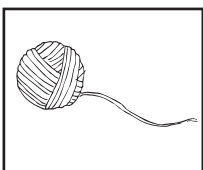

die Woll

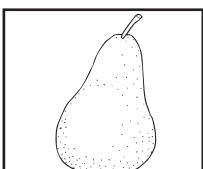

die Birn



12



**Kreise ein.
Welche Wörter enden auf -e ?**

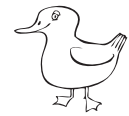

-e

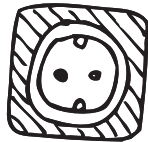
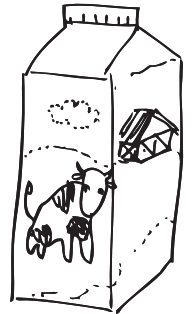
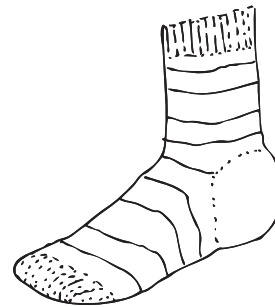
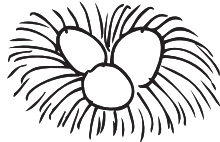
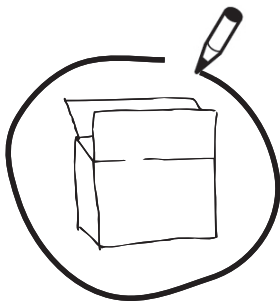
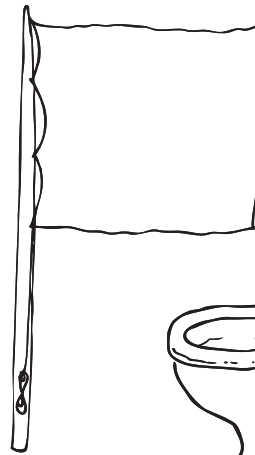
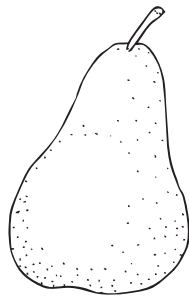
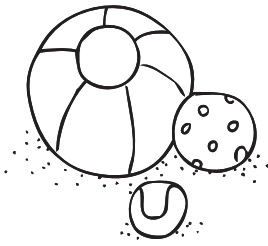

**Kreise ein.
Welche Wörter enden auf -e ?**



-e

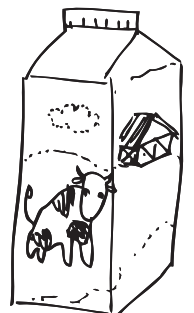
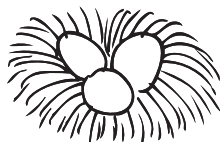
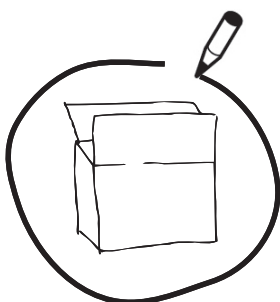
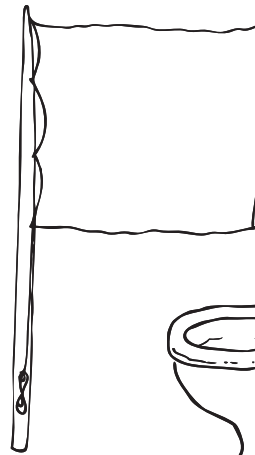
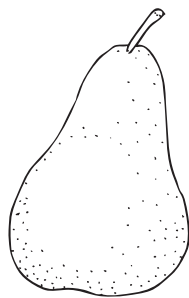
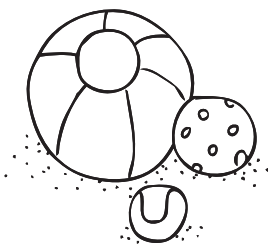



Kreise ein und schreibe.

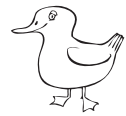

-e

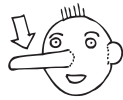
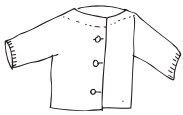

die Bälle



T	W	Z	P	S	F	G	H	N	J
K	I	S	T	E	K	L	X	A	Y
C	E	V	B	N	M	W	T	S	Z
P	G	S	D	S	O	C	K	E	F
G	E	H	J	B	K	L	Y	X	H
C	V	B	N	Ä	M	W	R	T	O
Z	P	W	O	L	K	E	S	D	S
F	G	H	J	L	K	L	Y	X	E
J	A	C	K	E	C	V	B	N	M
L	J	G	D	F	G	H	K	B	N
Q	W	R	T	P	S	T	U	F	E

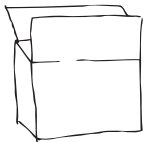
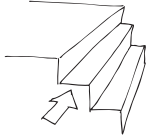

14



Kreise ein und schreibe.



-e



die Bälle



T	W	Z	P	S	F	G	H	N	J
K	I	S	T	E	K	L	X	A	Y
C	E	V	B	N	M	W	T	S	Z
P	G	S	D	S	O	C	K	E	F
G	E	H	J	B	K	L	Y	X	H
C	V	B	N	Ä	M	W	R	T	O
Z	P	W	O	L	K	E	S	D	S
F	G	H	J	L	K	L	Y	X	E
J	A	C	K	E	C	V	B	N	M
L	J	G	D	F	G	H	K	B	N
Q	W	R	T	P	S	T	U	F	E

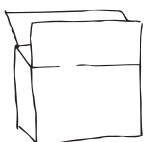
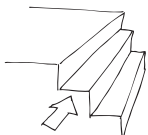

14

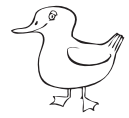

-e

W O L L E T Z P S F
Ä F G J N O T E H T
S M N B T V X C Y A
C S C H E R E R Z S
H W T R Z P S D F C
E B V B N M D R W H
R I B Z R T V N M E
Z R A B E V R T Z P
X N C B F T Z W R D
D E C V B R O S E W

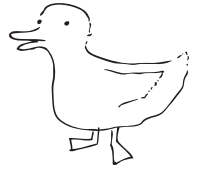

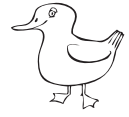

-e

W O L L E T Z P S F
Ä F G J N O T E H T
S M N B T V X C Y A
C S C H E R E R Z S
H W T R Z P S D F C
E B V B N M D R W H
R I B Z R T V N M E
Z R A B E V R T Z P
X N C B F T Z W R D
D E C V B R O S E W

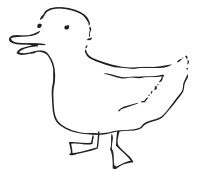



Schreibe.

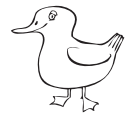

-e



Zeichne das Lösungswort.



Schreibe.

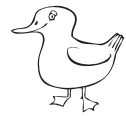

-e



Zeichne das Lösungswort.



-e



Schreibe.

A crossword puzzle grid with the following layout (rows from top to bottom):

- Row 1: 1 empty, 2 empty, 3 empty, 4 empty, 5 empty, 6 empty, 7 empty, 8 empty, 9 empty, 10 empty
- Row 2: 1 empty, 2 empty, 3 empty, 4 empty, 5 empty, 6 empty, 7 empty, 8 empty, 9 empty, 10 empty
- Row 3: 1 empty, 2 empty, 3 empty, 4 empty, 5 empty, 6 empty, 7 empty, 8 empty, 9 empty, 10 empty
- Row 4: 1 empty, 2 empty, 3 empty, 4 empty, 5 empty, 6 empty, 7 empty, 8 empty, 9 empty, 10 empty
- Row 5: 1 empty, 2 empty, 3 empty, 4 empty, 5 empty, 6 empty, 7 empty, 8 empty, 9 empty, 10 empty
- Row 6: 1 empty, 2 empty, 3 empty, 4 empty, 5 empty, 6 empty, 7 empty, 8 empty, 9 empty, 10 empty
- Row 7: 1 empty, 2 empty, 3 empty, 4 empty, 5 empty, 6 empty, 7 empty, 8 empty, 9 empty, 10 empty
- Row 8: 1 empty, 2 empty, 3 empty, 4 empty, 5 empty, 6 empty, 7 empty, 8 empty, 9 empty, 10 empty
- Row 9: 1 empty, 2 empty, 3 empty, 4 empty, 5 empty, 6 empty, 7 empty, 8 empty, 9 empty, 10 empty
- Row 10: 1 empty, 2 empty, 3 empty, 4 empty, 5 empty, 6 empty, 7 empty, 8 empty, 9 empty, 10 empty

Letters in the grid:

- Row 4, Column 2: R
- Row 3, Column 5: K
- Row 6, Column 8: r

Thick horizontal bar: Row 5, Columns 1-10.



Zeichne das Lösungswort.

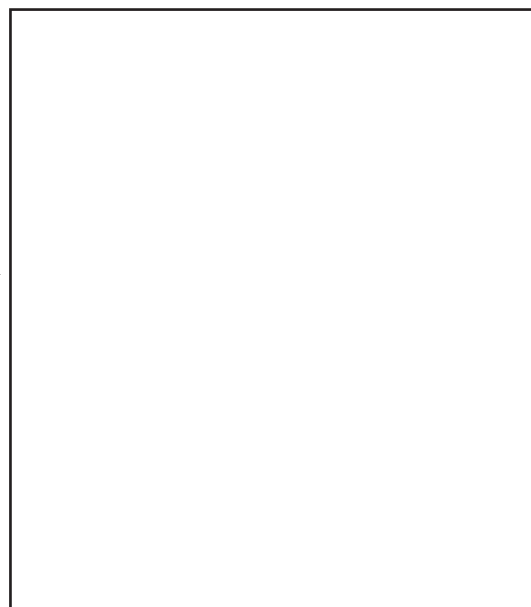

-e



Schreibe.

A crossword puzzle grid with the following layout (rows from top to bottom):

- Row 1: 1 empty, 2 empty, 3 empty, 4 empty, 5 empty, 6 empty, 7 empty, 8 empty, 9 empty, 10 empty
- Row 2: 1 empty, 2 empty, 3 empty, 4 empty, 5 empty, 6 empty, 7 empty, 8 empty, 9 empty, 10 empty
- Row 3: 1 empty, 2 empty, 3 empty, 4 empty, 5 empty, 6 empty, 7 empty, 8 empty, 9 empty, 10 empty
- Row 4: 1 empty, 2 empty, 3 empty, 4 empty, 5 empty, 6 empty, 7 empty, 8 empty, 9 empty, 10 empty
- Row 5: 1 empty, 2 empty, 3 empty, 4 empty, 5 empty, 6 empty, 7 empty, 8 empty, 9 empty, 10 empty
- Row 6: 1 empty, 2 empty, 3 empty, 4 empty, 5 empty, 6 empty, 7 empty, 8 empty, 9 empty, 10 empty
- Row 7: 1 empty, 2 empty, 3 empty, 4 empty, 5 empty, 6 empty, 7 empty, 8 empty, 9 empty, 10 empty
- Row 8: 1 empty, 2 empty, 3 empty, 4 empty, 5 empty, 6 empty, 7 empty, 8 empty, 9 empty, 10 empty
- Row 9: 1 empty, 2 empty, 3 empty, 4 empty, 5 empty, 6 empty, 7 empty, 8 empty, 9 empty, 10 empty
- Row 10: 1 empty, 2 empty, 3 empty, 4 empty, 5 empty, 6 empty, 7 empty, 8 empty, 9 empty, 10 empty

Letters in the grid:

- Row 4, Column 2: R
- Row 3, Column 5: K
- Row 6, Column 8: r

Thick horizontal bar: Row 5, Columns 1-10.



Zeichne das Lösungswort.

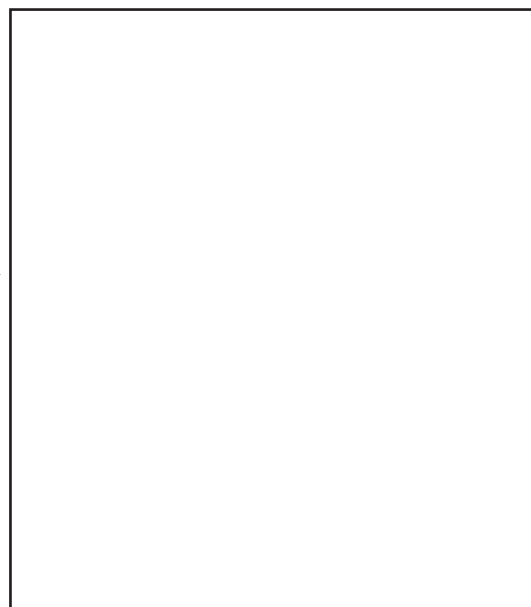



-er

Bei vielen Wörtern hörst du am Ende *a*.



Du schreibst aber **-er**.

e

r

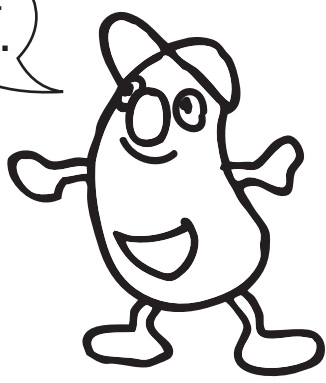

-er

Bei vielen Wörtern hörst du am Ende *a*.



Du schreibst aber **-er**.

e

r

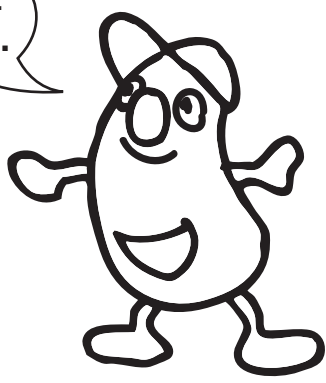



-er



Verbinde.



Kalender

Mutter

Lenker

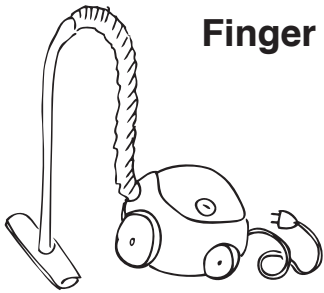

Finger

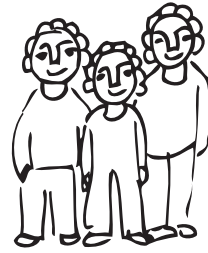

Kinder

Staubsauger



20



-er



Verbinde.

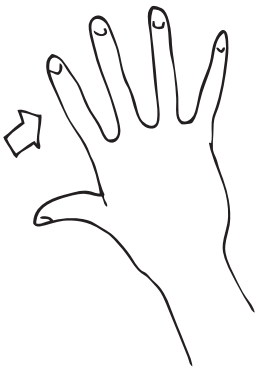

Kalender

Mutter

Lenker

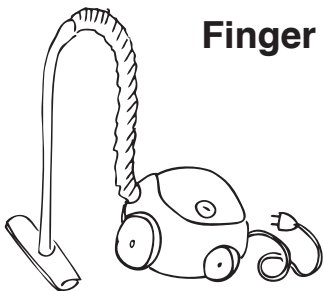

Finger



Kinder

Staubsauger



20



-er



Verbinde.

Roller

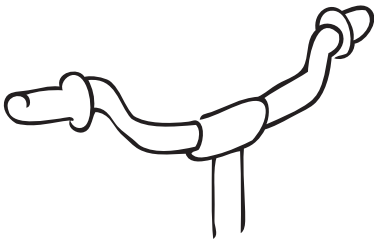

Eimer

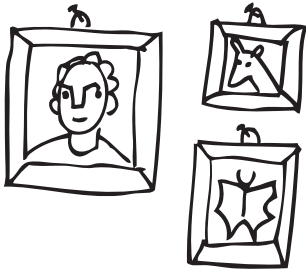

Bilder

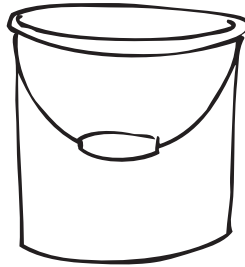

Fenster

Feder



Dreier

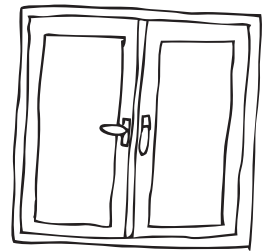

-er



Verbinde.

Roller

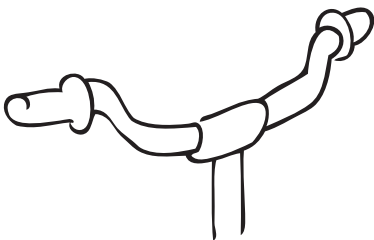

Eimer

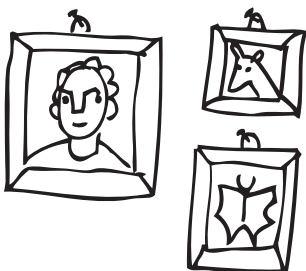

Bilder

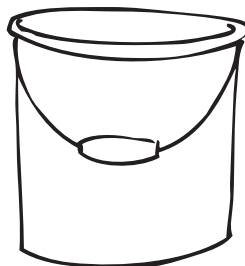

Fenster

Feder



Dreier

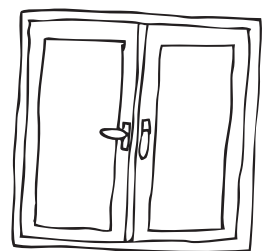



-er



Schreibe.

Denk daran: Im Wort wird klein geschrieben.

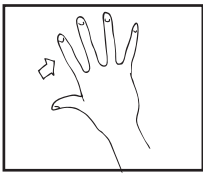

der Fing



der Finger der



die Kind



der Roll

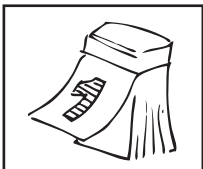

der Kalend



22



-er



Schreibe.

Denk daran: Im Wort wird klein geschrieben.

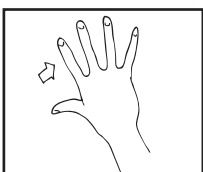

der Fing



der Finger der



die Kind



der Roll



der Kalend



22



-er



die Mutt



Blank writing lines

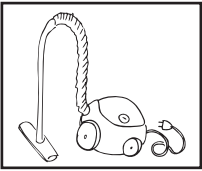

der Staubsaug



Blank writing lines

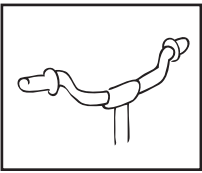

der Lenk



Blank writing lines

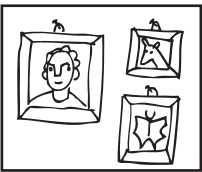

die Bild



Blank writing lines



-er



die Mutt



Blank writing lines

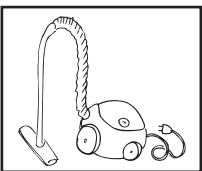

der Staubsaug



Blank writing lines

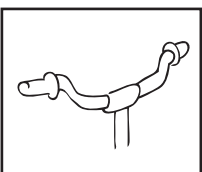

der Lenk



Blank writing lines

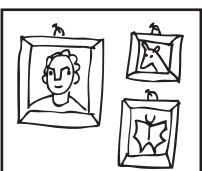

die Bild



Blank writing lines



-er



Schreibe.

Denk daran: Im Wort wird klein geschrieben.

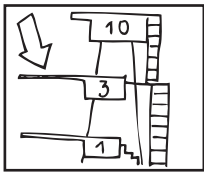

der Drei



Blank writing lines for the word 'der Drei'

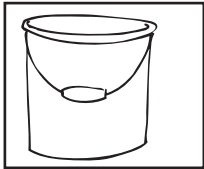

der Eim



Blank writing lines for the word 'der Eim'



die Fed



Blank writing lines for the word 'die Fed'

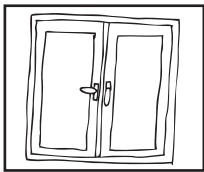

das Fenst



Blank writing lines for the word 'das Fenst'

24



-er



Schreibe.

Denk daran: Im Wort wird klein geschrieben.

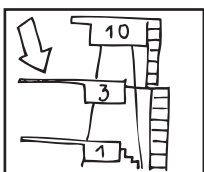

der Drei



Blank writing lines for the word 'der Drei'

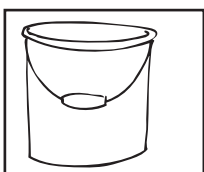

der Eim



Blank writing lines for the word 'der Eim'



die Fed



Blank writing lines for the word 'die Fed'

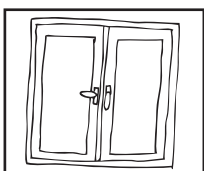

das Fenst



Blank writing lines for the word 'das Fenst'

24



-er



**Kreise ein.
Welche Wörter enden auf -er?**

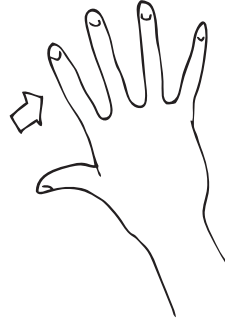
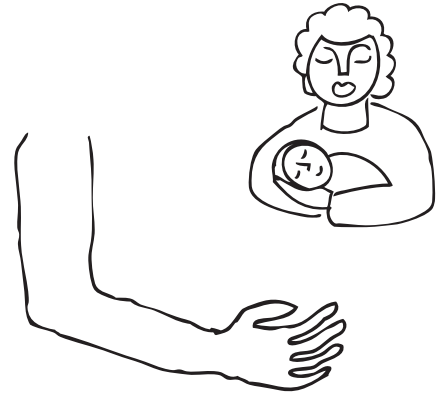
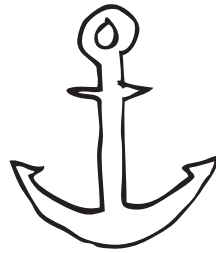

25



-er



**Kreise ein.
Welche Wörter enden auf -er?**

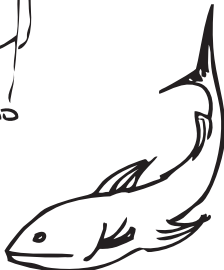
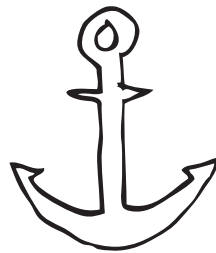

25



-er



Verbinde.



Feuer

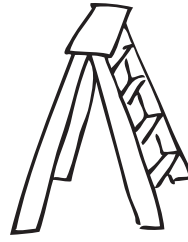

Maler



Laster

Poster

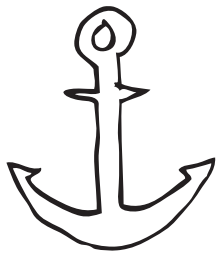

Anker

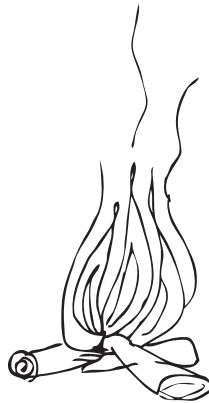

Leiter

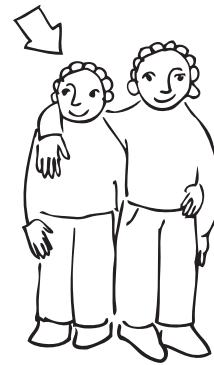

-er



Verbinde.



Feuer

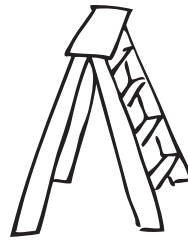

Maler



Laster

Poster

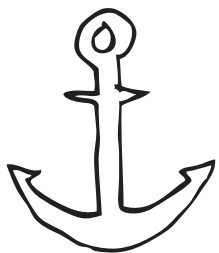

Anker

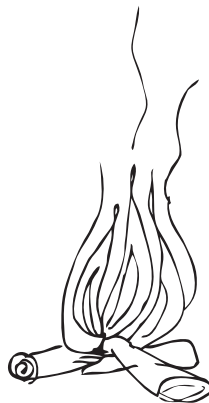

Leiter





Verbinde.



-er

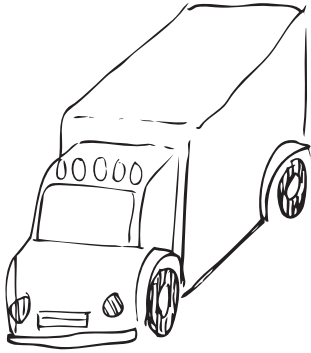

Vater

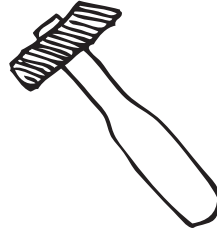

Finger

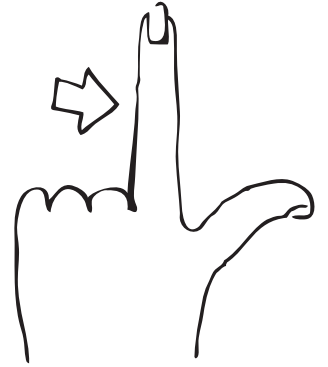

Koffer

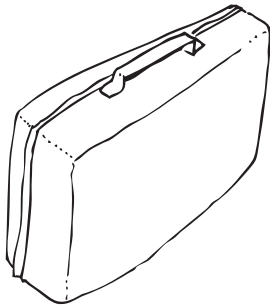

Hammer

Anspitzer

Bruder

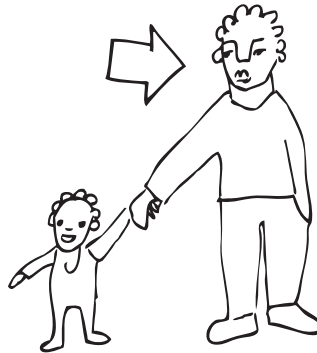

Verbinde.



-er

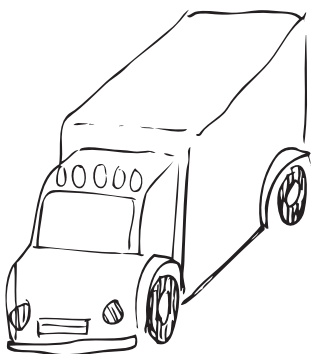

Vater



Finger

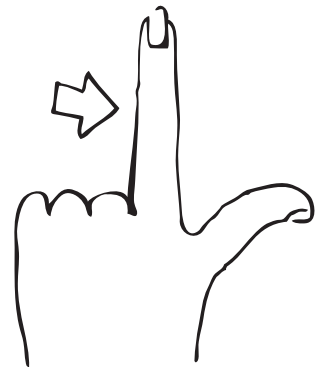

Koffer

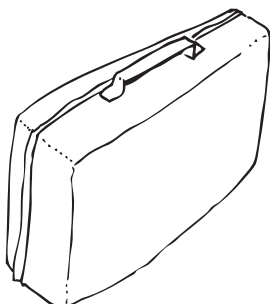

Hammer

Anspitzer

Bruder

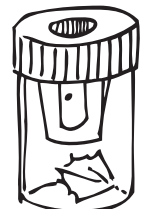
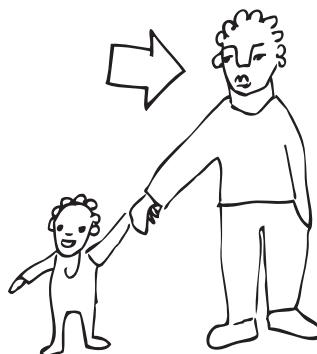



-er



Schreibe.

Denk daran: Im Wort wird klein geschrieben.



der Ank



der Anker der

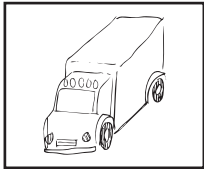

der Last



der Mat

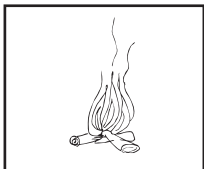

das Feu



28



-er



Schreibe.

Denk daran: Im Wort wird klein geschrieben.



der Ank



der Anker der

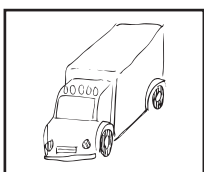

der Last



der Mat

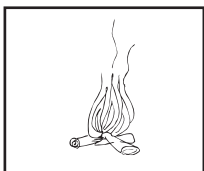

das Feu



28



-er

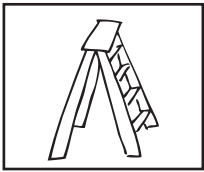

die Leit 

Blank writing lines for the word 'die Leit'

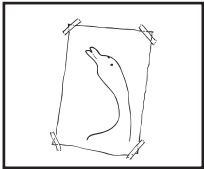

das Post 

Blank writing lines for the word 'das Post'



der Brud 

Blank writing lines for the word 'der Brud'

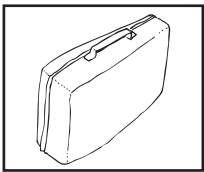

der Koff 

Blank writing lines for the word 'der Koff'



-er

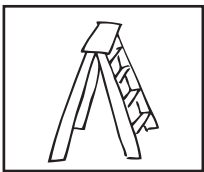

die Leit 

Blank writing lines for the word 'die Leit'

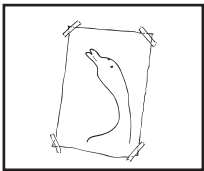

das Post 

Blank writing lines for the word 'das Post'



der Brud 

Blank writing lines for the word 'der Brud'

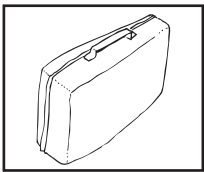

der Koff 

Blank writing lines for the word 'der Koff'



Schreibe.

Denk daran: Im Wort wird klein geschrieben.



-er

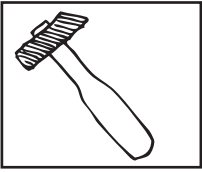

der Hamm 

Blank writing lines for the word 'der Hamm'

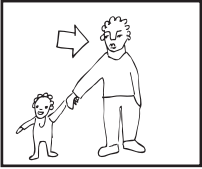

der Vat 

Blank writing lines for the word 'der Vat'



der Anspitz 

Blank writing lines for the word 'der Anspitz'

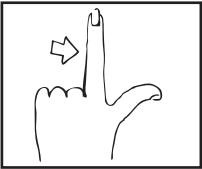

der Fing 

Blank writing lines for the word 'der Fing'

30



Schreibe.

Denk daran: Im Wort wird klein geschrieben.



-er

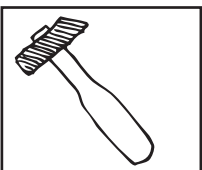

der Hamm 

Blank writing lines for the word 'der Hamm'

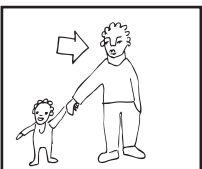

der Vat 

Blank writing lines for the word 'der Vat'

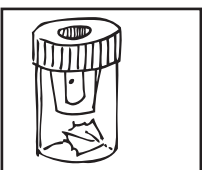

der Anspitz 

Blank writing lines for the word 'der Anspitz'

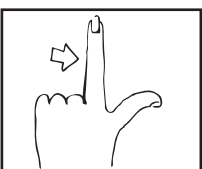

der Fing 

Blank writing lines for the word 'der Fing'

30



-er



Kreise ein.
Welche Wörter enden auf -er?

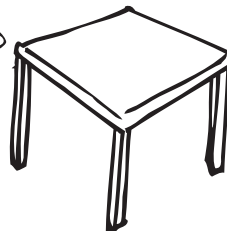
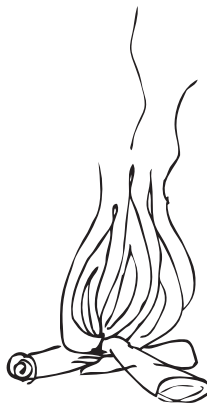
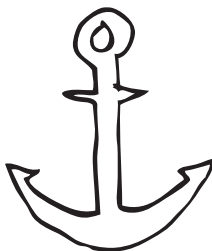
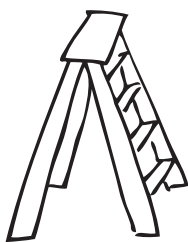

31



-er



Kreise ein.
Welche Wörter enden auf -er?

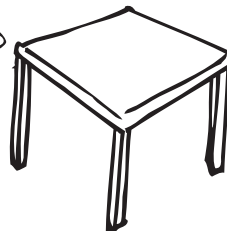
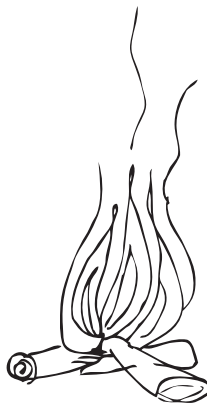
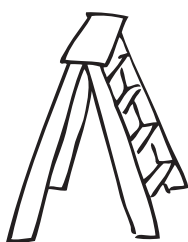

31



Kreise ein und schreibe.



das Feuer

W	F	I	N	G	E	R	R	P	F
W	R	Z	T	P	S	G	H	F	E
M	U	T	T	E	R	V	B	E	D
N	M	Q	W	L	R	T	Z	U	E
P	S	F	G	E	H	J	K	E	R
A	N	S	P	I	T	Z	E	R	K
N	L	Y	X	T	V	B	N	W	M
K	I	N	D	E	R	R	T	Z	P
E	S	F	G	R	H	J	K	L	X
R	B	K	A	L	E	N	D	E	R

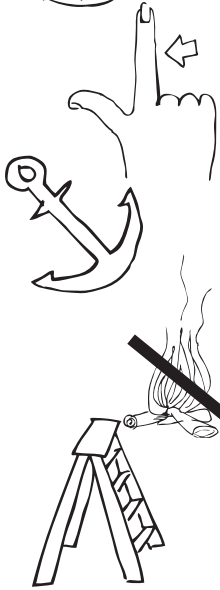

Kreise ein und schreibe.



das Feuer

W	F	I	N	G	E	R	R	P	F
W	R	Z	T	P	S	G	H	F	E
M	U	T	T	E	R	V	B	E	D
N	M	Q	W	L	R	T	Z	U	E
P	S	F	G	E	H	J	K	E	R
A	N	S	P	I	T	Z	E	R	K
N	L	Y	X	T	V	B	N	W	M
K	I	N	D	E	R	R	T	Z	P
E	S	F	G	R	H	J	K	L	X
R	B	K	A	L	E	N	D	E	R

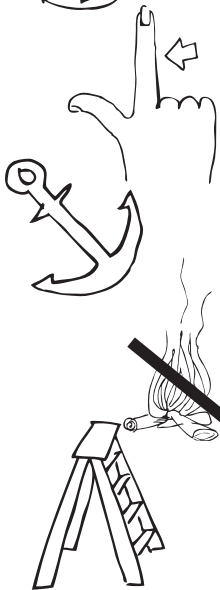



-er

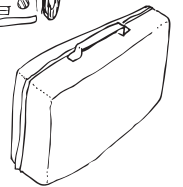
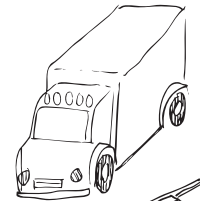
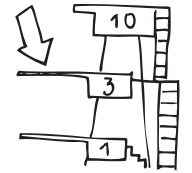
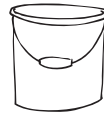
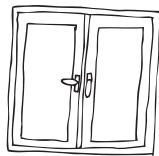

R W S R T Z P M S D
 O G T H J K L A Y K
 L L A S T E R L X O
 L C U V B N M E W F
 E R B I L D E R T F
 R Z S P S F G H J E
 K L A Y D R E I E R
 X C U V B N I M Q W
 R T G Z P S M D F G
 H F E N S T E R J K
 L Y R X C V R B M N



-er

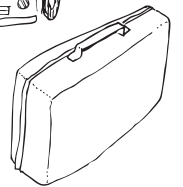
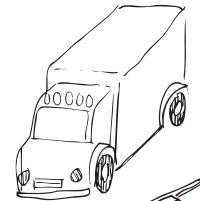
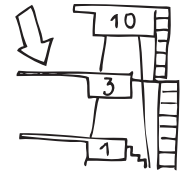
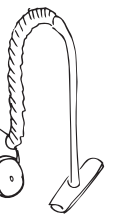
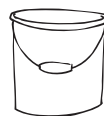
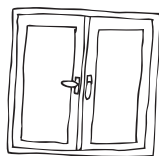

R W S R T Z P M S D
 O G T H J K L A Y K
 L L A S T E R L X O
 L C U V B N M E W F
 E R B I L D E R T F
 R Z S P S F G H J E
 K L A Y D R E I E R
 X C U V B N I M Q W
 R T G Z P S M D F G
 H F E N S T E R J K
 L Y R X C V R B M N



-er



Schreibe.



Zeichne das Lösungswort.

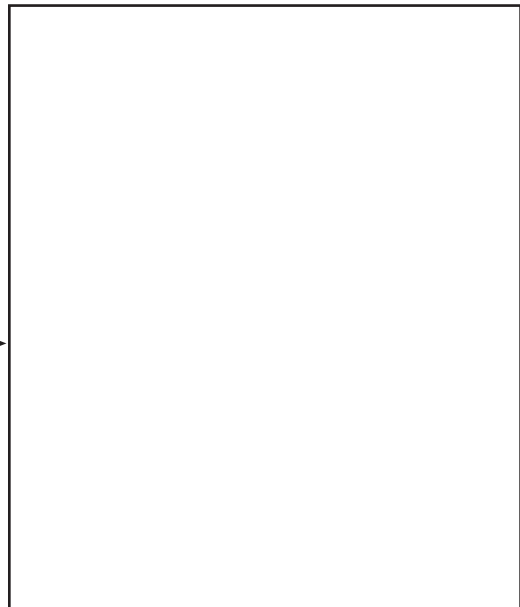

34



-er



Schreibe.



Zeichne das Lösungswort.

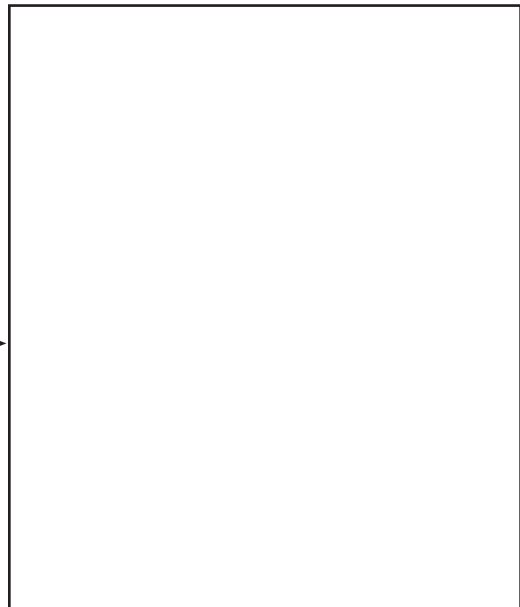

34



-er

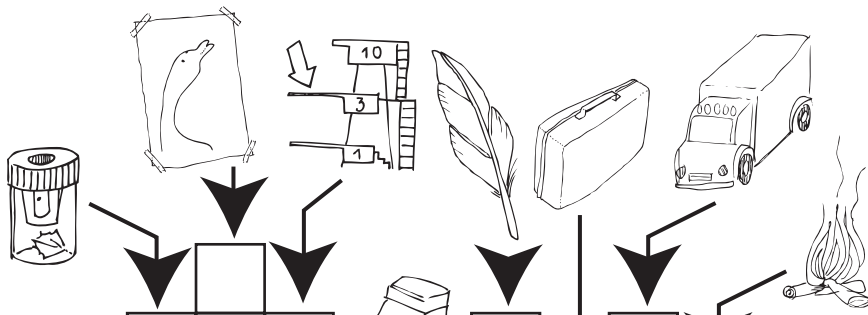

			c					
					f			
					f			
t								
z								



Zeichne das Lösungswort.



-er

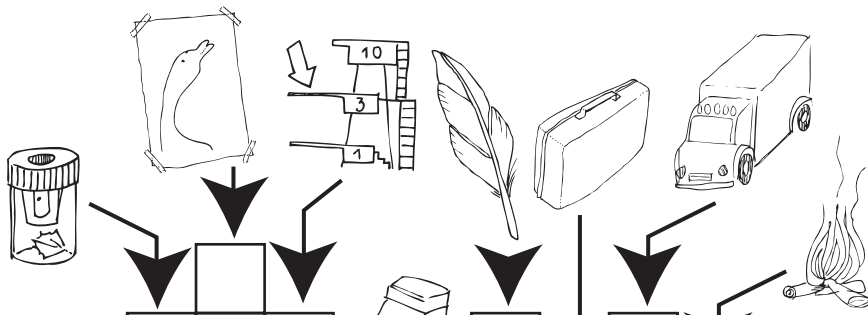

			c					
					f			
					f			
t								
z								



Zeichne das Lösungswort.

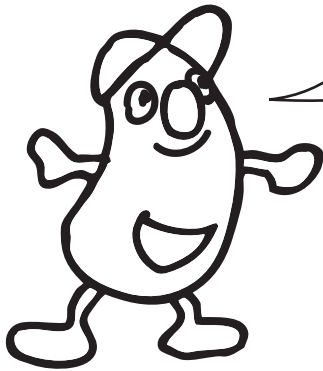

Herzlichen Glückwunsch!
Jetzt kennst du dich gut aus mit



-er.

Aber es
gibt auch
Ausnahmen...

Hihihi!

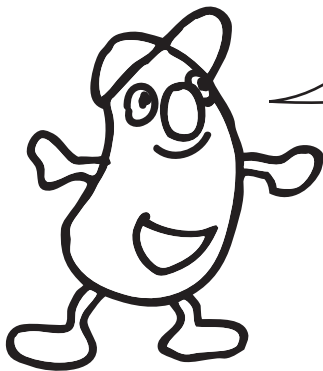

Herzlichen Glückwunsch!
Jetzt kennst du dich gut aus mit



-er.

Aber es
gibt auch
Ausnahmen...

Hihihi!



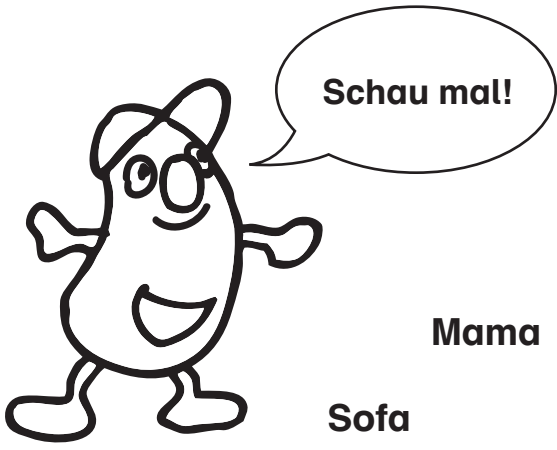

Schau mal!



Mama



Sofa



Pizza

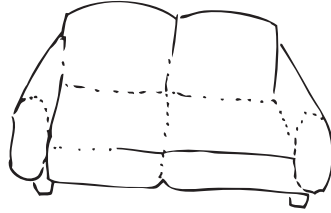

Panda

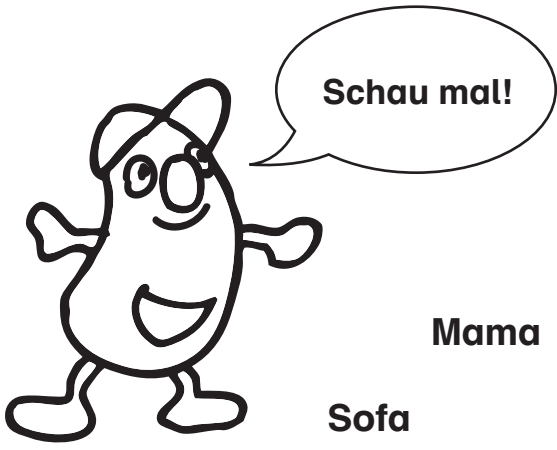
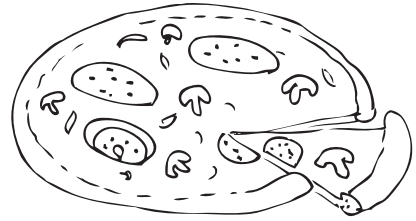

Schau mal!



Mama



Sofa

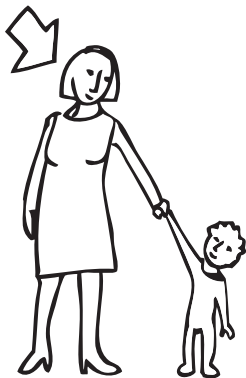

Pizza

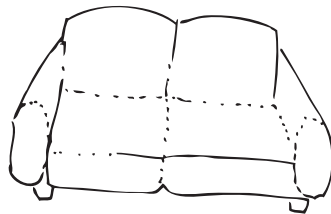

Panda

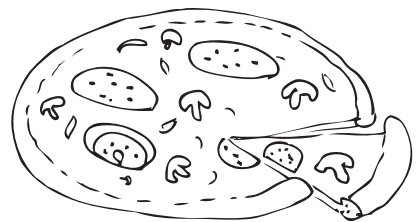



Lama



Papa

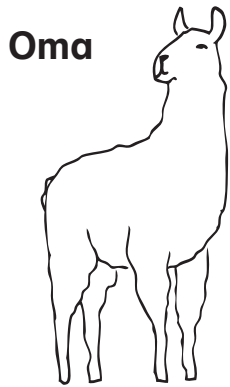

Oma

Opa



Lama



Papa

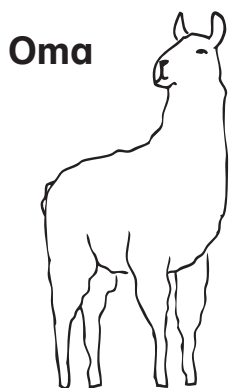

Oma

Opa



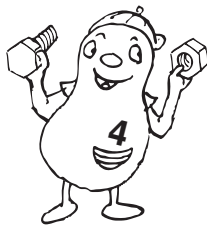

blog: lindegundula.wordpress.com

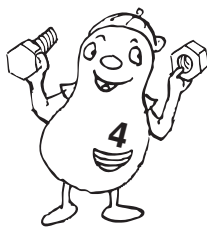

blog: lindegundula.wordpress.com